

Flanschlochauftung PN 16 / PN 10 (MG)
Partition for flange holes PN 16 / PN 10 (MG)
Répartition des trous PN 16 / PN 10 (MG)

2.5.05

PN 16/10 DN 50

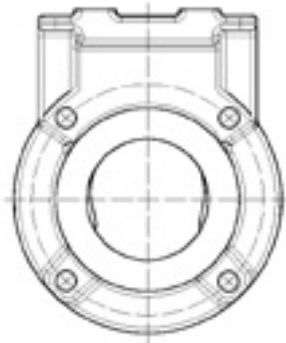

PN 16/10 DN 65–150

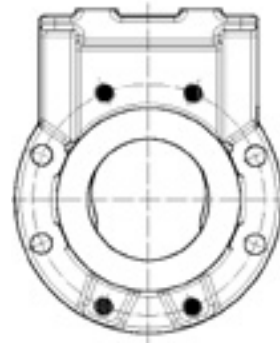

PN 10 DN 200

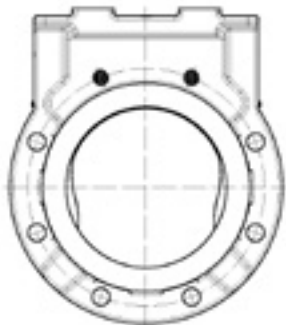

PN 16 DN 200–300
PN 10 DN 250–300

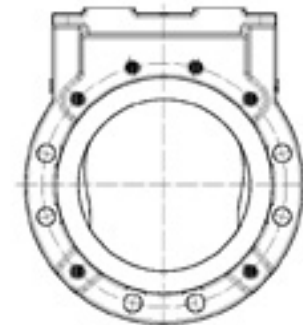

PN 16/10 DN 350–400

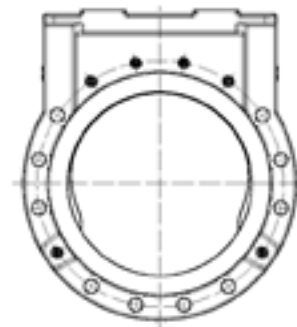

PN 16/10 DN 500–600

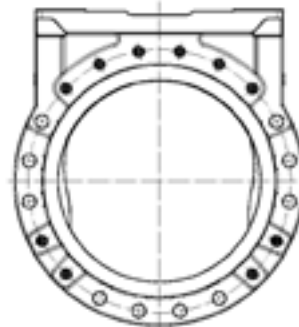

 Durchgehende Schraubenlöcher
Through flange bolt holes
Trous traversants

 Gewinde-Sacklöcher (Gewindetiefe siehe Massblatt)
Blind tapped holes (Depth of thread refer to dimensionsheet)
Trous borgnes (profondeur selon fiche technique)